

A

B

C

D

E

F

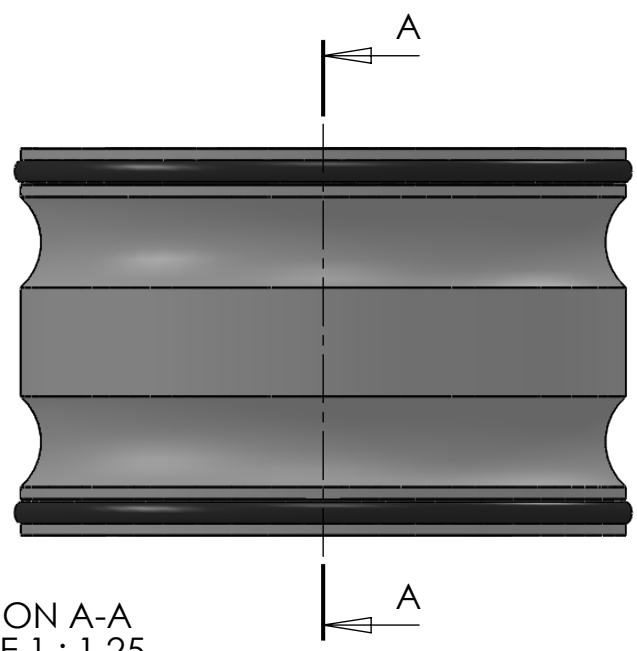
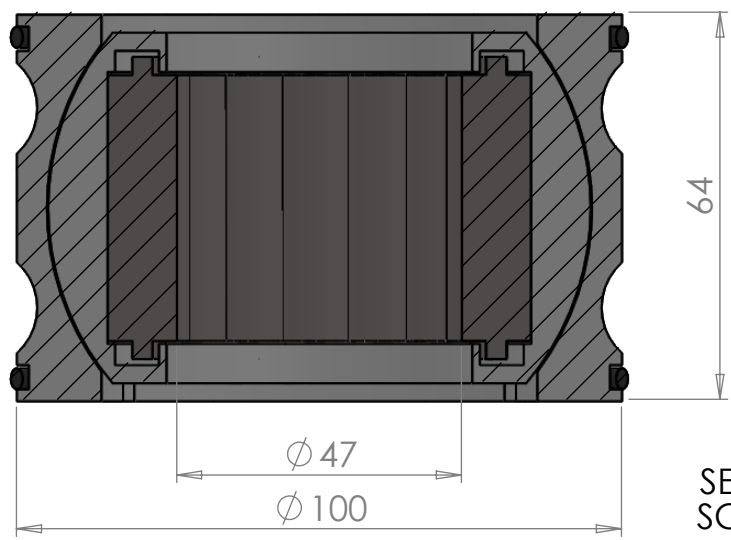

SECTION A-A
SCALE 1 : 1.25

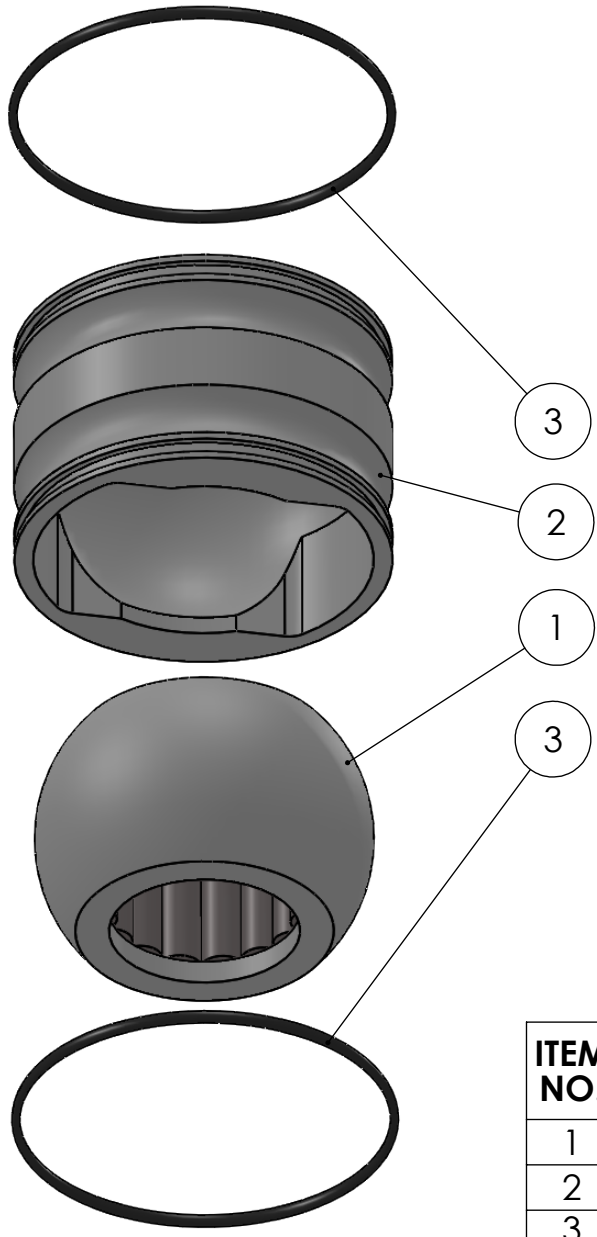

ITEM NO.	PART NUMBER	PART NAME	Default/ QTY.
1	M13-160-47	Ball with rollers	1
2	M48-100	House Ø100mm for Ø90mm ball	1
3	O-ring	Ø90 x 2,5	2

DWG NR / NAME: **6BB100047 / S-A bottom Roller bearing**

PROJECT: Shaft Ø47mm

DATE: 31.01.2012
MODIFY DATE: /

NAME: JR

SCALE / PAPER: 1:2 / A4

MATERIAL: g
WEIGHT:

LOCATION:
REV:

BATCH NR:
REKV.NR / ORDRE NR:
ORDRE DATO:
LEV.DATO:

Jefa Rudder
SYSTEMS
JEFA MARINE A/S
NIMBUSVEJ 2
2670 GREVE, DENMARK
Tlf: +45 4615 5210 & Fax: +45 4615208
Email: info@jefa.com www.jefa.com